



EX, SGX Vibrator Motors

Issued 04 May 09

Maintenance & Operation Manual

Mineral Processing, Industrial, & Environmental Applications

Derrick Corporation
590 Duke Road
Buffalo, New York 14225
Phone: 716.683.9010
Fax: 716.683.4991
www.derrickcorp.com

Oil & Gas Applications

Derrick Equipment Company
15630 Export Plaza Drive
Houston, Texas 77032
Phone: 281.590.3003
Toll Free: 1.866.DERRICK
Fax: 281.442.6948
www.derrickequipment.com

PRODUCT SUPPORT

Derrick offers 24-hour-per-day, 7-day-per-week product support. Contact information is listed below.

CONTACT INFORMATION			
Location	Telephone	Facsimile (FAX)	E-Mail / Website
Derrick Corporation 590 Duke Road Buffalo, New York 14225 USA	716.683.9010	716.683.4991	Technical Service techservice@derrickcorp.com
Derrick Equipment Company 15630 Export Plaza Drive Houston, Texas 77032 USA	281.590.3003	281.442.6948	General Manager erice@derrickequipment.com



CONTENTS

EX, SGX VIBRATOR MOTOR

	Page
Description	1
Repair Restrictions	2
Safety	2
Storage.....	3
Operating Environment	3
Replacement Parts.....	3
Removal and Installation.....	5
Electrical Connections.....	9
Preventive Maintenance.....	16
Bearing Replacement.....	17
Troubleshooting	26

The content of this document is subject to change at any time. Information provided does not cover all details or variations possible with DERRICK equipment, nor does it cover every contingency that may be met in conjunction with installation, operation, maintenance, or troubleshooting of the equipment. Should additional information be required, or should situations arise that are not covered by this manual, bring the matter to the attention of your local DERRICK representative or the Service Department at DERRICK Corporation in Buffalo, New York.

Copyright© 2009 by DERRICK CORPORATION



EX, SGX VIBRATOR MOTORS

DESCRIPTION

Motion is generated by the vibrator motors and transmitted to the screen frame to separate and convey solids over the screen panels. The EX and SGX motors are rated for continuous duty with Totally Enclosed Non-Ventilated (TENV) construction and permanently lubricated, sealed bearings. Depending on the screening equipment, one or two motors are installed.

Eccentric weights installed on the rotor shaft produce the motor's vibratory action. The weight, which is measured in in-lbs, varies depending on the application and equipment on which the vibrator motor is installed. The weight is stamped on the motor nameplate. When two vibrator motors are installed on a single screen frame, the motors are connected to cause the motors to rotate in opposite directions for maximum G-forces.

The vibrator motors must be operated at their rated three-phase supply voltage. Motors are available in both explosion-proof and non-explosion-proof versions. The model designation shown on the nameplate is defined as follows:

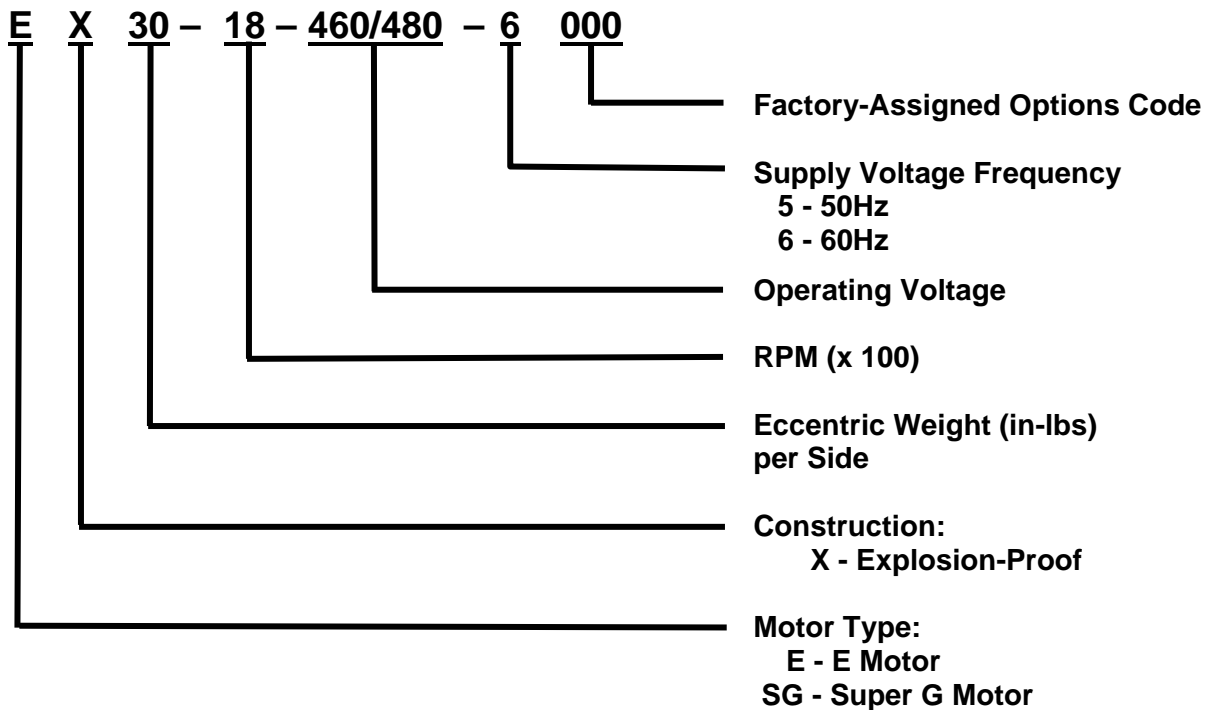

EX, SGX VIBRATOR MOTORS

REPAIR RESTRICTIONS

The Derrick EX and SGX motors have a CLASS I (flammable gas atmosphere) certification, which restricts the user to replacing only the following parts:

- Bearings
- Outer eccentric weights
- Power cord
- Junction box components

To maintain the flameproof rating of the motor, no parts beyond the bearing may be removed.

Also, while under warranty, no repairs of any kind are permitted; the motor may not be opened for any reason. If the motor fails while under warranty, contact the Derrick Service department for assistance. The warranty will be void, if it is determined that the motor has been opened during the warranty period.



Caution! Contact The Derrick Service Department If Motor Fails During The Warranty Period. All Warranties, Whether Stated Or Implied, Will Be Null And Void If The Motor Is Opened During The Warranty Period. Derrick Corporation May Not Be Held Responsible For Any Liabilities Incurred During, Or As A Result Of, Unauthorized Repair Attempts.

SAFETY

Successful and safe operation of Derrick vibrator motors requires proper handling, installation, operation, and maintenance. Failure to follow installation and maintenance requirements may result in personal injury, equipment failure, or property damage.

Only **trained, qualified personnel** should be involved in the installation, operation, and maintenance procedures. **All plant safety procedures must be observed.**

Qualified personnel must be familiar with the construction, installation, maintenance, and operation of the motor and must be aware of any hazards associated with operation of the equipment. In addition, personnel must be trained and authorized to energize, de-energize, clear, ground, and tag circuits and equipment in accordance with established safety practices and be trained in proper use and care of personal protective equipment in accordance with established safety practices.



WARNING! ALL DERRICK VIBRATOR MOTORS MUST BE INSTALLED AND GROUNDED IN ACCORDANCE WITH ALL APPLICABLE ELECTRICAL CODES.



WARNING! TO AVOID SERIOUS PERSONAL INJURY, BE SURE THAT EQUIPMENT IS LOCKED OUT, TAGGED OUT, AND DE-ENERGIZED BEFORE PERFORMING MAINTENANCE AND/OR ADJUSTMENTS.



WARNING! MOTOR HOUSING BECOMES HOT DURING OPERATION AND MAY CAUSE SEVERE BURNS. DO NOT TOUCH MOTOR HOUSING DURING OR IMMEDIATELY AFTER MOTOR HAS BEEN OPERATING.

STORAGE

If a spare motor is to be placed in storage, the instructions in the following paragraphs must be observed to protect the stored motor and maintain the warranty.

New Motors

New spare vibrator motors should be stored in a clean, dry (50 percent relative humidity or less), warm location. The storage location should not undergo severe daily temperature changes.

Used Motors

Before storing a motor that has been in service, run the unit for approximately one hour to ensure complete heating and to dissipate any internal moisture. At the end of the run, shut down the motor and allow it to cool. Follow all applicable lock out and tag out rules when removing the motor.

While motor is in storage, periodically check the integrity of the winding insulation using a megohmmeter. Maintain a continuous record of megohmmeter readings, and immediately investigate any significant decrease in insulation resistance.

OPERATING ENVIRONMENT

Derrick vibrator motors are designed to operate in ambient temperatures slightly higher than 104°F (40°C). If higher temperatures are anticipated, please contact the Derrick Technical Service Department for assistance. **DO NOT install hoods or enclosures** that may cause inadequate ventilation, which could reduce vibrator life.

REPLACEMENT PARTS

The cross-sectional view and parts list below include replacement parts that are available for the Derrick EX and SGX vibrator motors. This information should be used to identify and order replacement or spare parts for the motor. To simplify parts location, the parts list contains separate part number columns for the EX and SGX motors.

EX, SGX VIBRATOR MOTORS

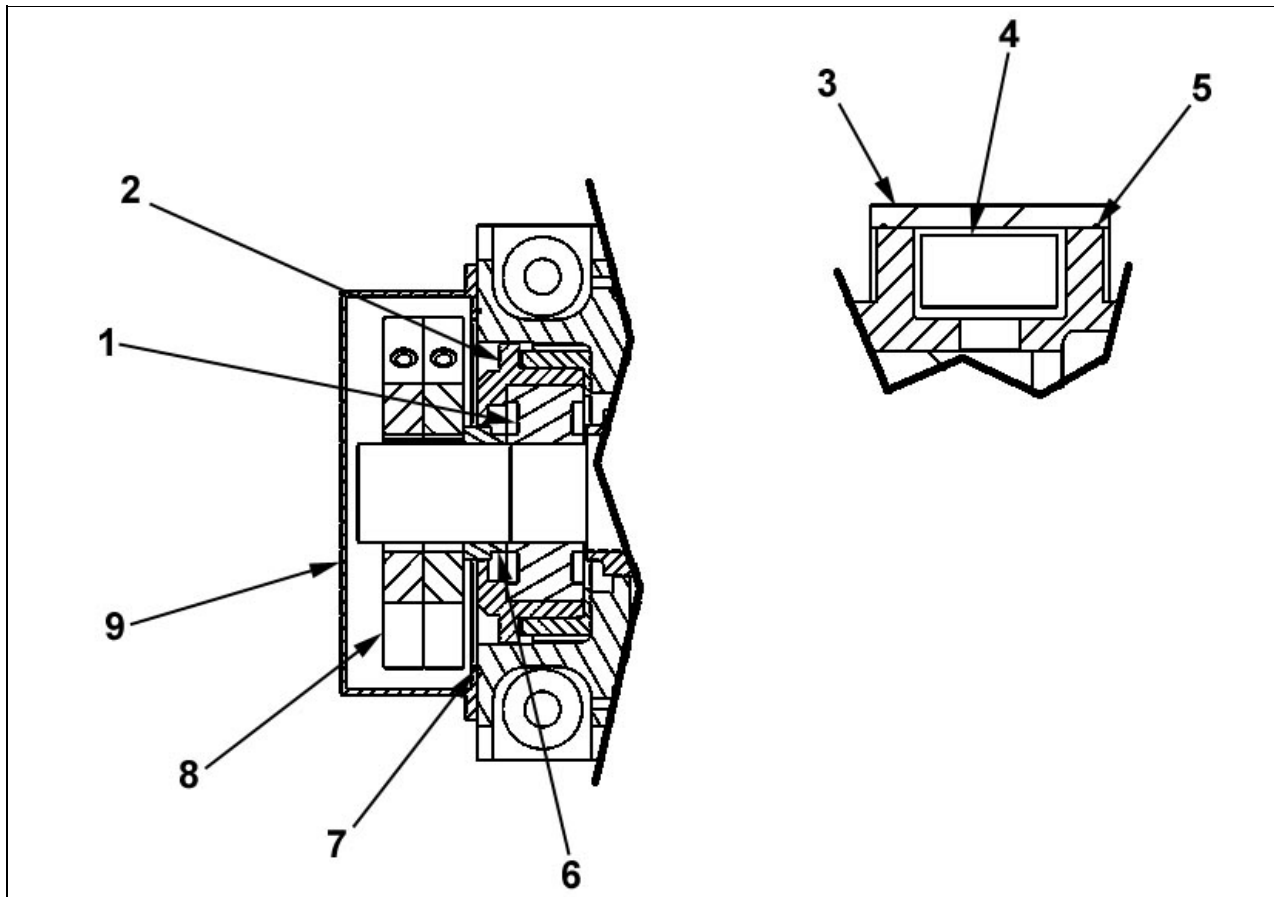

Ref. Dwg. 14274-00

Replacement Parts – EX & SGX Motors

No.	Description	EX Part No.	SGX Part No.	Qty
1	Bearing	PP1097-BRG	G0001960	2
2	Bearing Mount	12733-00-002	14266-01	2
3	Junction Box Cover	12739-00	12739-00	1
4	Terminal Block Assembly	11006-00-001	11006-00-001	1
5	O-Ring, 5.250 x 0.070	G0003627	G0003627	1
6	Bearing Spacer	12742-00	14269-01	2
7	O-Ring, 7.90 x 0.070	PP1503	PP1503	2
8	Weights, Outer	Serial Number Req'd	Serial Number Req'd	A/R
9	End Cover	12736-00-001	12736-00-001	2

REMOVAL AND INSTALLATION

The removal and installation procedures below include photos for a typical motor. While motor appearances vary between the models covered, these differences do not affect removal and installation.

Tool Kits

Tool kits containing all necessary equipment for removing and installing motor bolts are available from Derrick. Kit part numbers are as follows:

Part No.	Description
<i>Kit No. G0003029 - 3/4" Hex Hd Bolt</i>	
G0002020	Torque Wrench, 200-600 ft-lbs, 3/4" Drive
G0003026	Extension, 3/4" Drive x 8" Lg
G0003027	Deep Socket, 3/4" Drive x 1-1/8"
G0003028	Box End Wrench, Offset, 1-1/8"
G0003030	Breaker Bar, 3/4"





<i>Kit No. G0002161 - 1" Bolt With 5/8" Socket Hd</i>	
G0002020	Torque Wrench, 200-600 ft-lbs, 3/4" Drive
G0001941	Deep Socket, 3/4" Drive x 1-7/16"
G0002160	Hex Bit Socket, 1/2" Drive x 5/8"
G0002163	Breaker Bar, 1/2" Drive
842-06	Box End Wrench, Offset, 1-7/16"

<i>Kit No. G0002162 - 1" Bolt With 3/4" Socket Hd</i>	
G0002020	Torque Wrench, 200-600 ft-lbs, 3/4" Drive
G0001941	Deep Socket, 3/4" Drive x 1-7/16"
G0002164	Hex Bit Socket, 1/2" Drive x 3/4"
G0002163	Breaker Bar, 1/2" Drive
842-06	Box End Wrench, Offset, 1-7/16"

EX, SGX VIBRATOR MOTORS

Safety

Be sure to follow the warnings listed below before, during, and after removal or installation of the vibrator motor.

	WARNING! MOTOR HOUSING BECOMES HOT DURING OPERATION AND MAY CAUSE SEVERE BURNS. DO NOT TOUCH MOTOR HOUSING DURING OR IMMEDIATELY AFTER MOTOR HAS BEEN OPERATING.
	WARNING! SCREEN PANELS WILL BE DAMAGED IF STRUCK BY HARDWARE OR TOOLS. EITHER REMOVE SCREEN PANELS OR PROTECT FROM DAMAGE DURING MOTOR REMOVAL OR INSTALLATION.
	WARNING! BE SURE THAT HANDLING DEVICES HAVE SUFFICIENT LIFTING CAPACITY TO SAFELY HANDLE THE WEIGHT OF THE EQUIPMENT.
	WARNING! HIGH VOLTAGE MAY BE PRESENT. ALWAYS OPEN FUSED DISCONNECT SUPPLYING ELECTRIC POWER TO THE EQUIPMENT, AND LOCK-OUT AND TAG-OUT POWER SUPPLY BEFORE PERFORMING ANY MAINTENANCE AND/OR ADJUSTMENTS OF EQUIPMENT.
	WARNING! MOTOR MAY BE DAMAGED BY STORING IN A HIGH HUMIDITY ENVIRONMENT (GREATER THAN 50% RH). OUT-OF-SERVICE MOTOR(S) MUST BE STORED IN A LOW-HUMIDITY ENVIRONMENT.

Motor Handling

When lifting motor, position lifting sling at the center of the motor case as shown.

DO NOT PINCH MOTOR POWER CORD WHEN INSTALLING LIFTING SLING. To prevent damage to power cord when lifting motor assembly, always keep sling next to motor case.



During Motor Removal:

Attach lifting sling to motor case, and connect to overhead lifting device **before** removing mounting hardware for motor assembly.



During Motor Installation:

Keep lifting sling attached to motor until mounting hardware has been installed and secured to screen frame.

Mounting Hardware Installation

 **Note! Due To High Torque Applied During Installation, Re-Use Of Motor Mounting Hardware Is Not Recommended. All Hardware Components Should Be Replaced Whenever A Motor Is Removed.**

Depending on motor type, either 3/4" or 1" bolts are used for securing the motor(s) to the screen frame. Refer to table below for hardware sizes for each motor. When installing the bolts, note that the 3/4" motor bolts are installed from the underside of the screen frame (Figure 1), while the 1" bolts are installed from the top of the motor. Both configurations require hardened washers under the bolt heads as well as under the Flex-Loc nuts.

Part No.	Dimensions	Motor	Bolt Head	Nut Size / Wrench	Photo
9903-04	1" x 4.5" Lg	E, EX	3/4" Skt Hd	1-7/16" / Deep Socket	
G0001973	3/4" x 4" Lg	SG, SGX	1-1/8" Hex Hd	1-1/8" / Deep Socket	

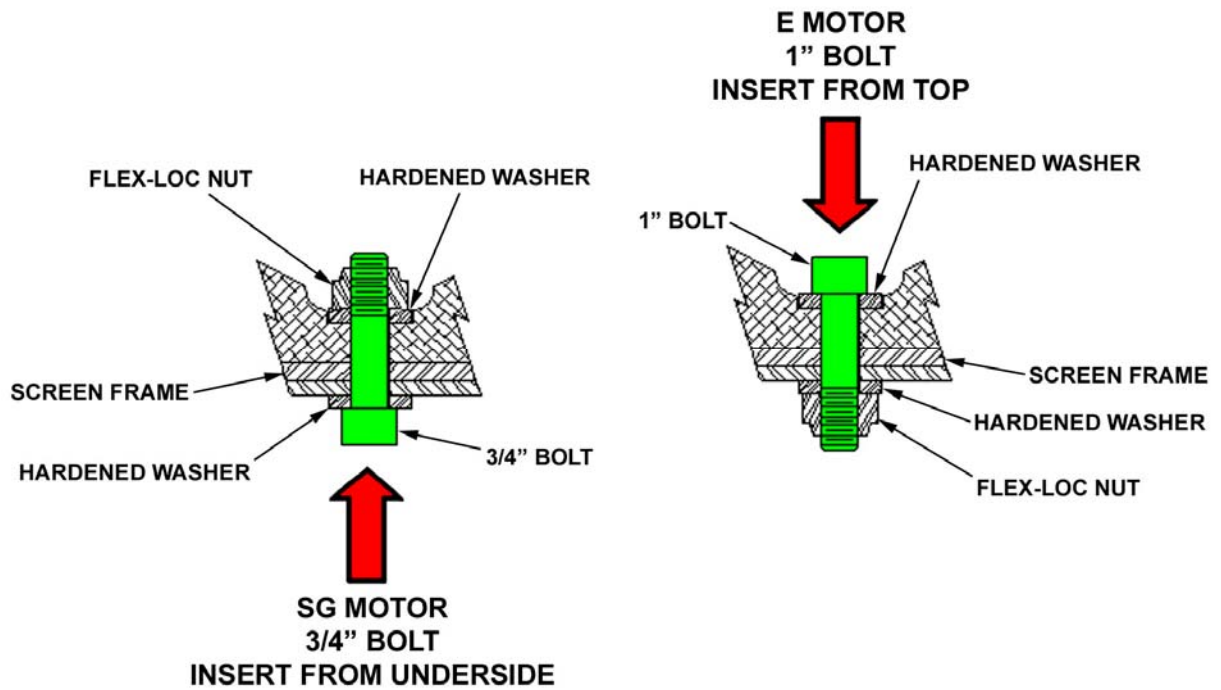

Figure 1 Motor Bolt Installation

EX, SGX VIBRATOR MOTORS

Motor Positioning and Mounting



1 - Using overhead lifting device, position vibrator motor over screen frame.



2 - For motor secured with 1" bolts, insert bolt with hardened washer from top of motor. Lower motor onto screen frame, and insert bolt through screen frame.



3 - For 1" bolts, apply anti-seize compound to bolt threads, and install hardened washer and Flex-Loc nut on each bolt. Use a hex key bit to restrain bolt head, while tightening nut from underside of screen frame.



4 - For 1" bolt installation, with bolt head restrained use a torque wrench with 1-7/16" deep socket to tighten nut to 400 ft-lbs. For 3/4" bolt installation, position motor on screen frame and align mounting holes with screen frame. Insert bolts (without anti-seize compound applied) with hardened washers through motor holes from underside of screen frame. Install hardened washers and nuts on top, and tighten to 300 ft lbs.







ELECTRICAL CONNECTIONS

The following instructions describe the connections at both ends of the power cord. To ensure that correct connections, always tag leads for identification before disconnecting from the terminals.

The Derrick vibrator motor must be operated at the required voltage and frequency. Refer to the data plate on the motor case for the motor's voltage and frequency requirements. Prior to installing a new vibrator motor, verify that the electrical power configuration corresponds to the electrical requirements specified on the motor.

Safety

Electrical connections should be performed only by trained, qualified personnel familiar with high-voltage applications and knowledgeable of National Electrical Code (NEC) standards and any other state or local codes that may apply to installation of industrial equipment.

	WARNING! MOTOR MAY BE DAMAGED BY INCORRECT SUPPLY POWER. BE SURE THAT VOLTAGE AND FREQUENCY ARE WITHIN $\pm 10\%$ OF MOTOR DATA PLATE SPECIFICATIONS.
	WARNING! ELECTRICAL CONNECTIONS MUST BE MADE IN ACCORDANCE WITH THE NATIONAL ELECTRICAL CODE (NEC) AND ALL APPLICABLE LOCAL CODES. FAILURE TO COMPLY MAY RESULT IN AN UNSAFE CONDITION THAT COULD INJURE PERSONNEL OR DAMAGE EQUIPMENT. ENSURE THAT ALL ELECTRICAL AND CONDUIT CONNECTIONS ARE SECURE.
	WARNING! EITHER REMOVE SCREEN PANELS OR PROTECT FROM DAMAGE DURING MOTOR REMOVAL OR INSTALLATION. SCREEN PANELS WILL BE DAMAGED IF STRUCK BY HARDWARE OR TOOLS.
	WARNING! HIGH VOLTAGE MAY BE PRESENT. ALWAYS OPEN FUSED DISCONNECT SUPPLYING ELECTRIC POWER TO THE EQUIPMENT, AND LOCK OUT AND TAG OUT POWER SUPPLY BEFORE PERFORMING ANY MAINTENANCE AND/OR ADJUSTMENTS OF EQUIPMENT.
	WARNING! MOTOR MAY BE DAMAGED IF STORED IN A HIGH-HUMIDITY ENVIRONMENT (GREATER THAN 50% RH). BE SURE THAT MOTOR WAS STORED IN A LOW-HUMIDITY ENVIRONMENT.
	WARNING! BE SURE THAT MOTOR IS PROPERLY GROUNDED.
	WARNING! MOTOR HOUSING BECOMES HOT DURING OPERATION AND MAY CAUSE SEVERE BURNS. DO NOT TOUCH MOTOR HOUSING DURING OR IMMEDIATELY AFTER MOTOR HAS BEEN OPERATING.

EX, SGX VIBRATOR MOTORS

Connections to Motor

The procedure below describes motor cord connections to the motor. If replacing a cable, tag all leads for identification before disconnecting old cable. The EX and SGX motors use either the following connection styles:

Terminal Block - Cord is fed through the side of the motor junction box and connected to a terminal block inside the junction box

Power Connector - Cord is fed through the junction box cover, which contains a female power connector where connections are made. This connector plugs into a male plug in the junction box.

Terminal Block Style

1. Remove cover from motor junction box.
2. Carefully feed the wires through the elbow installed in the motor junction box (Figure 2).
3. Install and tighten gland assembly components in elbow, using care to avoid over-tightening backnut. To prevent over-tightening, stop tightening backnut when red seal begins to swell.
4. Install two O-rings over leads inside junction box, slide both O-rings into threaded hole in box, and position one O-ring at each end of threaded hole to suspend the leads in the center of the hole.



Note! Be sure that O-rings are properly installed, as they prevent chafing of leads due to abrasion against threaded hole.

5. Route leads as shown, dressing carefully to prevent leads from contacting each other or the interior of the connection box.
6. Secure black, white, red, orange, and blue leads to studs as marked on terminal block using external tooth lockwashers and Flex-Loc[®] nuts. Secure green lead to GROUND terminal using lockwasher and screw.
7. Apply RTV-108-10.1 silicone sealant to leads (Figure 3) for vibration-proofing. Also, be sure to fill threaded hole for additional protection against chafing.
8. Place cover on motor junction box, and install and tighten four screws to 250 in-lbs.

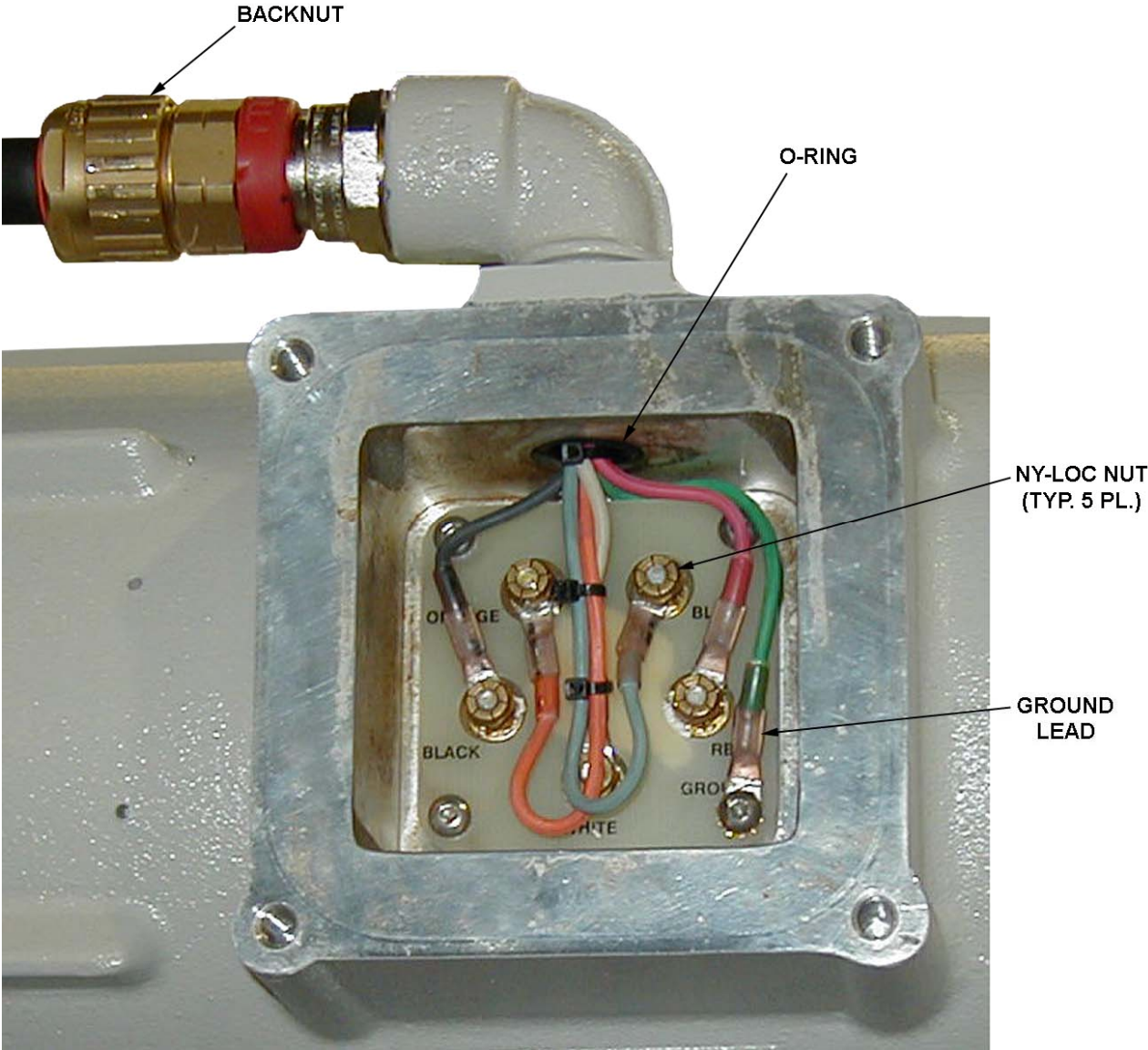

Figure 2 Motor Cord Connections to Terminal Block

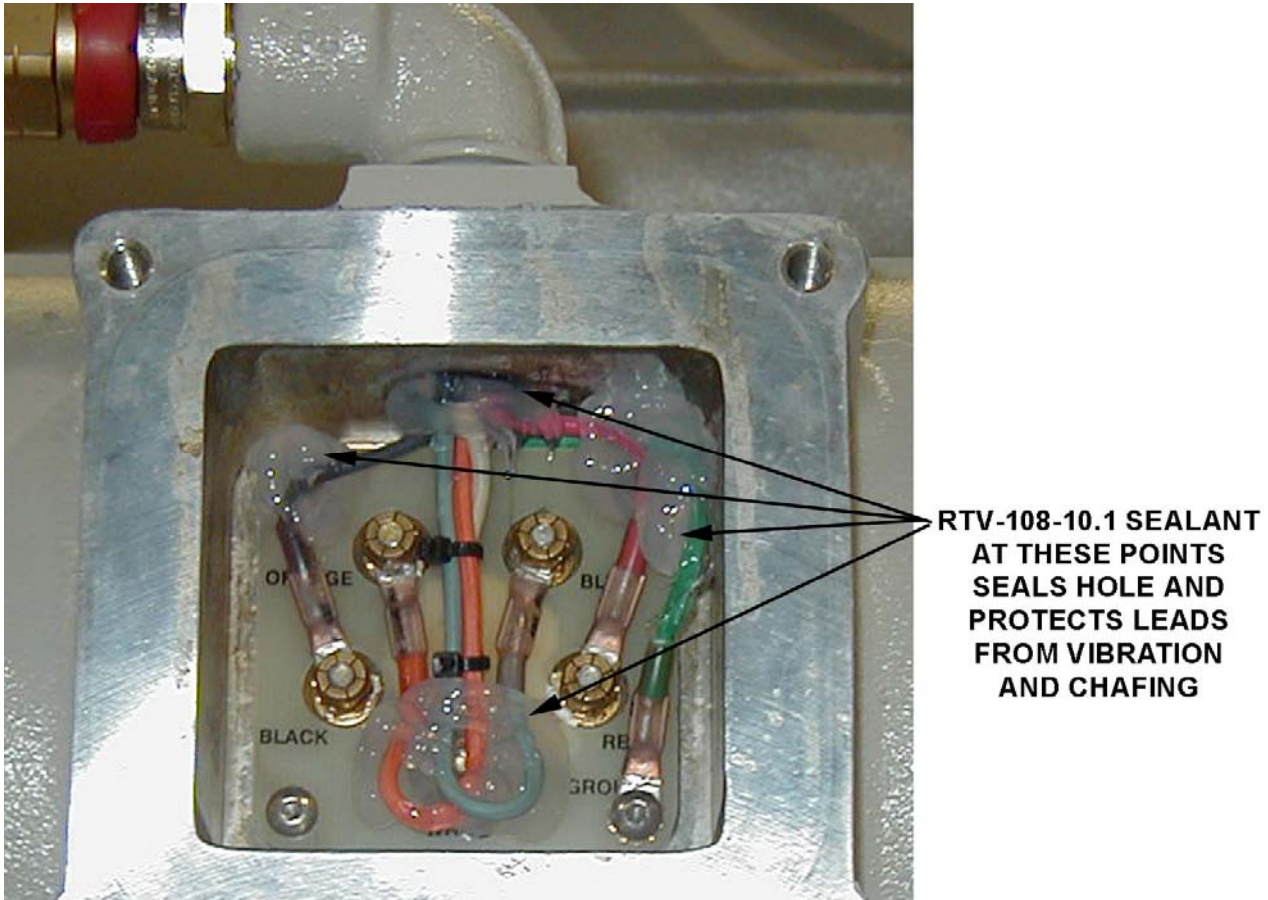

Figure 3 RTV Sealant Application

Power Connector Style

1. Remove cover from motor junction box, and discard O-ring (Figure 4).
2. Insert motor cord leads through junction box cover.
3. Match leads to power connector markings, and connect leads to terminals as shown.
4. Apply anti-seize compound to front gland nut, and install and tighten in threaded opening in cover.
5. Install remaining gland components, and tighten backnut only sufficiently to cause red seal to begin to protrude. Do not over-tighten backnut.

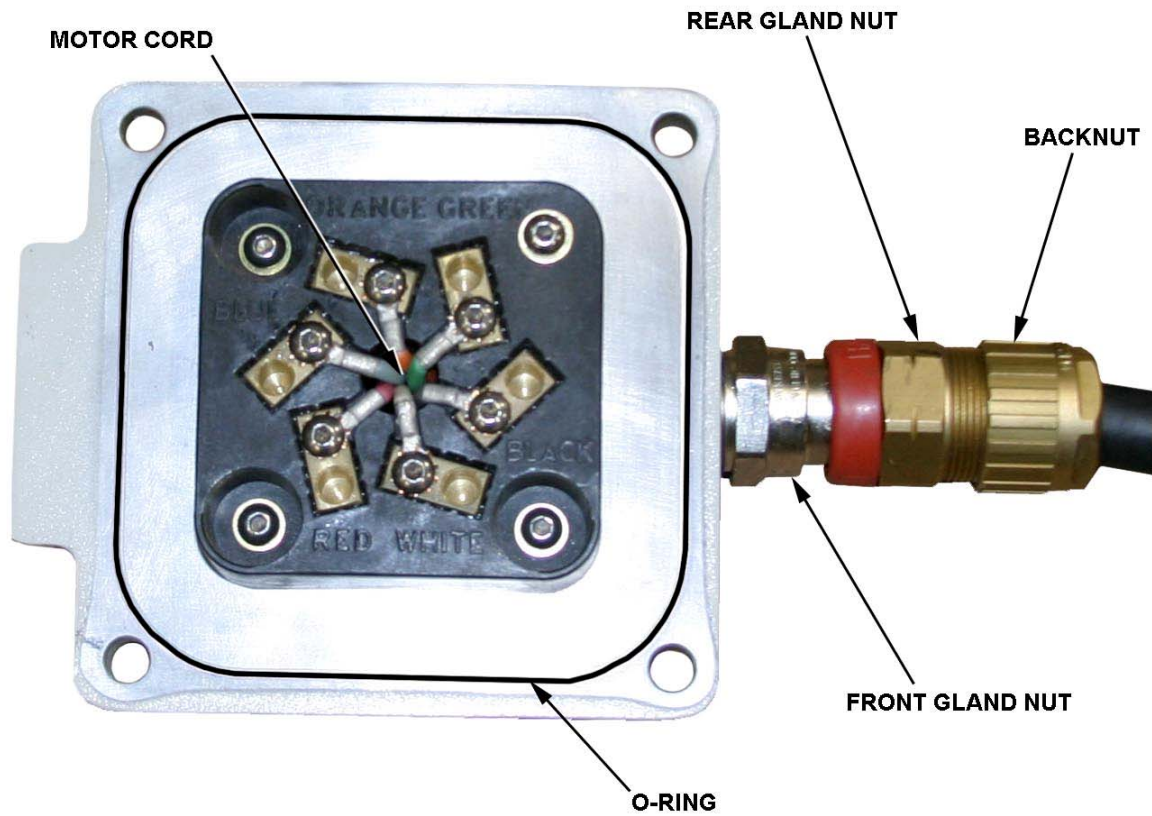

Figure 4 Motor Cord Connections to Power Connector

6. Apply small amount of LubriPlate 5555, part number L0107-007, or UL-approved equivalent to new O-ring, and install O-ring in groove of cover.
7. Align cover mounting holes with holes in junction box, ensure that O-ring remains in place, and install cover by engaging power connector plug and receptacle.



Note! Be sure that connector halves mate easily and that O-ring remains in place during assembly.

8. Secure cover to junction box with four socket head cap screws, and tighten to 250 in. lbs.
9. Check for proper fit between cover and junction box surface by attempting to insert a 0.001" shim between the two parts around the entire mating area circumference. If the shim can be inserted at any location, remove the cover and correct any defect.

Connecting Motor Cord To Junction Box

Motor leads may be connected inside a round or rectangular junction box. If a round junction box is installed, the motor leads are connected to the machine leads with wire nuts and tape (Figure 5). If a rectangular junction box is present, the leads are connected to the terminal block shown in Figure 6 for dual motors or Figure 7 for a single motor. Refer to the schematic diagram in your equipment manual for additional assistance in connecting single or dual vibrator motor(s). The following procedures cover all types of installations. Select the procedure that applies to the electrical configuration of your machine.

Motor Power Connections to Round Junction Box

1. For machines having an elbow installed in a round junction box, wrap leads loosely with electrical tape to facilitate threading through elbow in conduit.
2. Pass leads through junction box elbow and into junction box (Figure 5). Thread front gland nut into junction box elbow, and tighten securely. Thread rear gland nut onto front gland nut, and tighten securely. Thread and tighten backnut onto cable gland. Using wire nuts and electrical tape, connect leads to corresponding wire colors inside junction box as shown.



Note! In dual-motor machines, be sure to connect one motor in reverse polarity so that motors rotate in opposite directions.

Motor Power Connections to Rectangular Junction Box

1. Pass leads into junction box (Figures 6 and 7), and thread front gland nut into junction box and tighten securely.
2. Thread and tighten rear gland nut onto front gland nut.
3. Thread and tighten backnut onto rear gland nut.
4. Insert wire colors into proper locations on terminal block as shown, noting that for dual-motor machines leads for one motor are reversed. Tighten terminal screws to secure leads.



Note! In dual-motor machines, be sure to connect one motor in reverse polarity so that motors rotate in opposite directions.

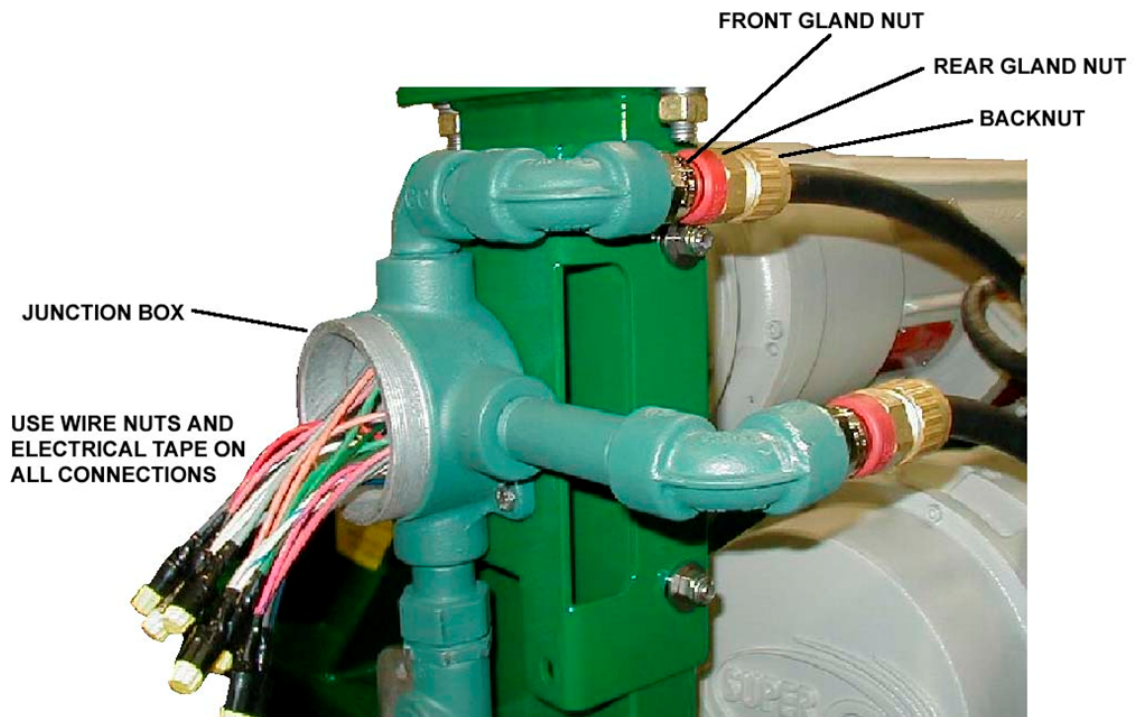

Figure 5 Dual Motor Connections - Round Junction Box

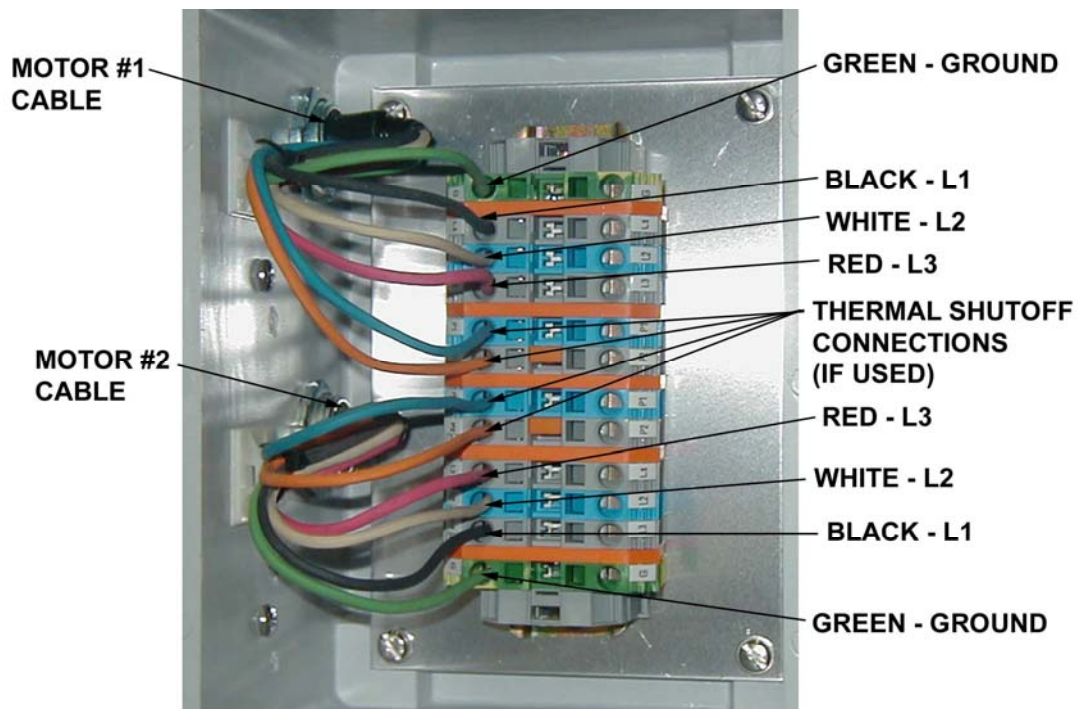

Figure 6 Junction Box Electrical Connections - Dual Motor

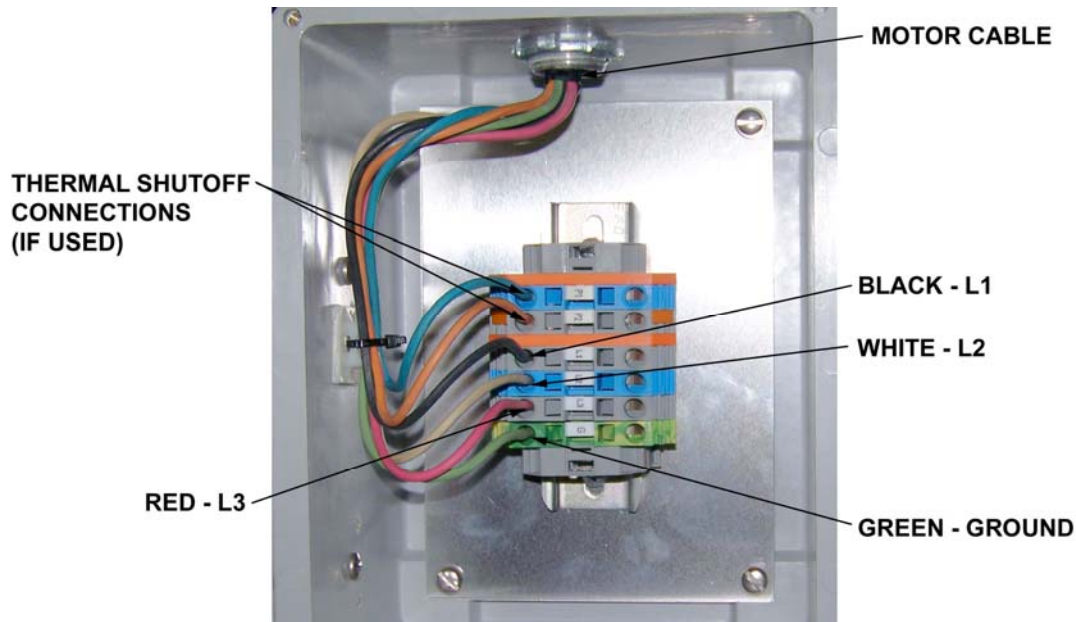

Figure 7 Junction Box Electrical Connections - Single Motor

Motor Thermal Switch Connections

If desired, the thermal switch embedded in the motor's stator winding may be connected to turn on an indicator to inform personnel that the motor is operating within the normal temperature range. Alternatively, the switch may be connected to an overload protection device in the motor starter box to shut down the motors in case of high stator temperature. To permit connection to an external device, the blue and orange leads from the thermal switch are brought out to terminals P1 and P2 in the equipment electrical junction box. To wire the thermal switch, connect leads from the external indicator and power source to terminals P1 and P2 in the junction box.

If the stator temperature becomes abnormally high, the normally closed (N.C.) thermal switch contacts open. Depending on the connection scheme, the open contacts either turn off the indicator or shut down the motor(s). The indicator and power source are customer-supplied.

Motor Test

After completing the electrical connections, test the motor to confirm proper operation. For dual-motor installations check that motors rotate in opposite directions. Reverse the leads of one motor to correct the direction of rotation, if necessary.

PREVENTIVE MAINTENANCE

Routine preventive maintenance will ensure maximum life for the vibrator motor. While the maintenance schedule in this section is flexible, modifications should be based on operating experience at your facilities.

A maintenance log will help establish and monitor a service schedule that is correct for your equipment. The maintenance log should contain the following information:

- Motor model and serial number from motor data plate
- Power requirements
- Voltage reading across L1 to L2, L1 to L3, and L2 to L3
- Amperage reading across L1 to L2, L1 to L3, and L2 to L3

	<p>WARNING! TO AVOID SERIOUS PERSONAL INJURY BE SURE EQUIPMENT IS LOCKED OUT, TAGGED OUT, AND DE-ENERGIZED PRIOR TO PERFORMING MAINTENANCE AND/OR ADJUSTMENTS.</p>
---	---

VIBRATOR MOTOR MAINTENANCE	
Maintenance Action	Frequency
Using a water hose, clean process material from exterior of motor case*.	Daily or as required
Inspect motor cable for signs of deterioration or damage.	Each shift or as required
Using a torque wrench, verify that motor mounting bolt torque is in accordance with torque listed in Motor Removal and Installation.	After first 40 hours of operation; once each year

* *The vibrator motor is designed to dissipate heat through the motor case. Buildup of process material on the motor case exterior prevents proper heat dissipation and may cause the motor to overheat.*

EX, SGX VIBRATOR MOTORS

BEARING REPLACEMENT

The following bearing replacement procedure applies only to EX and SGX motors that are no longer under warranty. During the warranty period the motor is not to be opened for any reason, as this will void the warranty. Contact the Derrick Service department for assistance if a motor fails while under warranty.



NOTE! All warranties, whether stated or implied, will be void if the Derrick motor is opened during the warranty period.

Materials Required

The bearing replacement kits shown below contain the bearings and associated components required for both ends of the motor. Derrick recommends replacement of bearings as a set. Failure to replace both bearings may result in premature failure of the newly installed bearing.



NOTE! Bearings in Derrick vibrator motors are custom designed with loose internal clearances and are packed with Mobilith SHC[®] 100 grease to prolong life. Regardless of supplier, bearings must be packed with this grease or equivalent. Derrick does not recommend use of bearings from an alternative supplier.

EX MOTOR BEARING REPLACEMENT KITS		
Part Number	Description	Qty
Bearing Replacement Kit - G0001703		
G0001696	Bolt, Jack, Hex Skt Hd, M8-1.25 x 70mm, Aly Stl	2
PP1097-BRG	Bearing, Vibrator	2
PP1503	O-Ring, 7.90 ID x .070 Cross Section, Viton	2
12733-00-002	Mount, Bearing, Vibrator, A4140 Stl	2
G0002250	Grease, Vibrator, SCH-100, 10-Oz. Tube	1
Bearing Replacement Kit With Tools - G0001702		
G0001696	Bolt, Jack, Hex Skt Hd, M8-1.25 x 70mm, Aly Stl	2
PP1097-BRG	Bearing, Vibrator	2
PP1503	O-Ring, 7.90 ID x .070 Cross Section, Viton	2
12733-00-002	Mount, Bearing, Vibrator, A4140 Stl	2
G0001698	Torque Wrench, 3/8" Drive, 150 to 750 In Lb	1
G0008935	Driver, Hex, 6mm Male, 6.063 L X 3/8" Drive	1
G0001700	Wrench, Hex, T-Handle, 5mm Alloy Stl	1
G0003126	Wrench, Ratchet, 3/8" Drive, Ind. Finish	1
G0008317	Socket, Allen Bit, 5mm Lg, 3/8" Drive	1
G0002250	Grease, Vibrator, SCH-100, 10-Oz. Tube	1

SGX MOTOR BEARING REPLACEMENT KITS		
Part Number	Description	Qty
Bearing Replacement Kit - G0003904		
G0001696	Bolt, Jack, Hex Skt Hd, M8-1.25 x 70mm, Aly Stl	2
G0001960	Bearing, Vibrator	2
PP1503	O-Ring, 7.90 ID x .070 Cross Section, Viton	2
14266-01	Mount, Bearing, Vibrator, A4140 Stl	2
G0002250	Grease, Vibrator, SCH-100, 10-Oz. Tube	1
Bearing Replacement Kit With Tools - G0003905		
G0001696	Bolt, Jack, Hex Skt Hd, M8-1.25 x 70mm, Aly Stl	2
G0001960	Bearing, Vibrator	2
PP1503	O-Ring, 7.90 ID x .070 Cross Section, Viton	2
14266-01	Mount, Bearing, Vibrator, A4140 Stl	2
G0001698	Torque Wrench, 3/8" Drive, 150 to 750 In Lb	1
G0008935	Driver, Hex, 6mm Male, 6.063 L X 3/8" Drive	1
G0001700	Wrench, Hex, T-Handle, 5mm Alloy Stl	1
G0003126	Wrench, Ratchet, 3/8" Drive, Ind. Finish	1
G0008317	Socket, Allen Bit, 5mm Lg, 3/8" Drive	1
G0002250	Grease, Vibrator, SCH-100, 10-Oz. Tube	1

Tools Required

Following is a recommended tool list for use during the bearing replacement procedure:

- Torque wrench (200 to 1000 in lbs)
- Hex wrench (5mm)
- Hex wrench (6mm)
- Dental pick or similar tool
- Clean, absorbent cloths
- Safety glasses
- Heat-resistant gloves (250° F or higher)
- Welder's torch
- Bearing heater





Work Area Environment

A well-lighted area with sufficiently large work-surface area is required to work on the motor. The work surface should be clean to prevent contamination of the new bearings and motor interior.

EX, SGX VIBRATOR MOTORS

Safety

The following WARNINGS apply to the bearing replacement procedure. Be sure to read and understand these WARNINGS **before** proceeding.

	WARNING! MOTOR HOUSING BECOMES HOT DURING OPERATION AND MAY CAUSE SEVERE BURNS. DO NOT TOUCH MOTOR HOUSING DURING OR IMMEDIATELY AFTER MOTOR HAS BEEN OPERATING.
	WARNING! ALL OPERATING AND MAINTENANCE PERSONNEL MUST READ AND UNDERSTAND ALL SAFETY INFORMATION IN THIS MANUAL BEFORE WORKING WITH THE EQUIPMENT.
	WARNING! HIGH VOLTAGE MAY BE PRESENT. BE SURE FUSED DISCONNECT SUPPLYING ELECTRIC POWER TO THIS EQUIPMENT IS OPEN. LOCK OUT AND TAG OUT POWER SUPPLY TO PREVENT ACCIDENTAL APPLICATION OF POWER WHILE MAINTENANCE AND/OR ADJUSTMENTS ARE IN PROGRESS.
	WARNING! TO PREVENT SERIOUS EYE INJURY OR PERMANENT LOSS OF VISION, WEAR SAFETY GLASSES DURING THIS PROCEDURE.

Bearing Replacement

The procedure below describes replacing the bearing on one end. Repeat the procedure for the second bearing.

	NOTE! Remove vibrator motor from equipment before performing bearing replacement (refer to Motor Removal and Installation). Bearings will fail prematurely if new bearings become contaminated during replacement.
---	---

Bearing Removal

The following procedure describes bearing removal for one side of the motor. Repeat the procedure for bearing at opposite end.



1 - Using a 5mm hex wrench, remove eight socket head cap screws securing cover to bearing housing; support cover as last screw is removed.



2 - Remove cover, and remove O-ring using a dental pick or similar tool. Discard O-ring.

Bearing Removal (Cont'd)

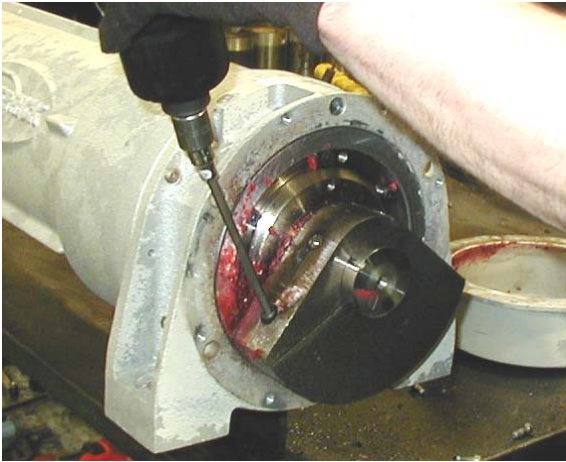

3 - Using a 6mm hex wrench, loosen socket head set screw securing outboard eccentric weight(s) to motor shaft. Note that more than one eccentric weight may be installed in this position.

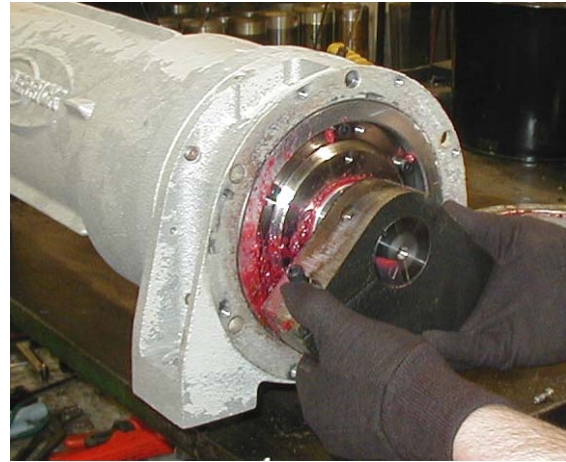

4 - Remove outboard eccentric weight(s) from motor shaft.



5 - Using a soft absorbent cloth, remove excess lubricant from components. Do not use compressed air for cleaning as this may drive contaminants into motor.

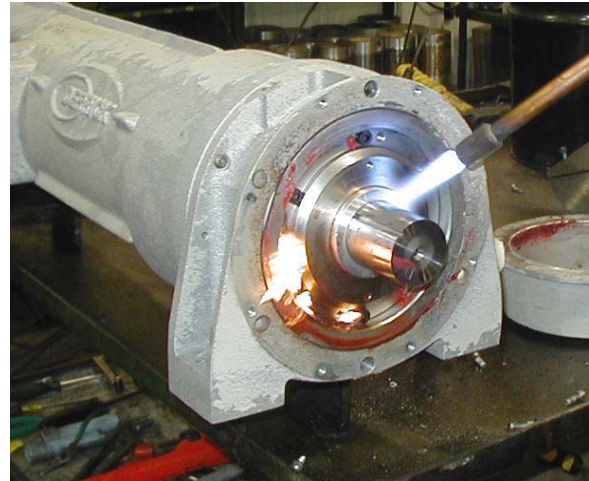

6 - Using a torch with a diffused flame, gently heat spacer for no more than 10 seconds to approximately 200°-230°F (93°-110°C) to facilitate removal.

EX, SGX VIBRATOR MOTORS

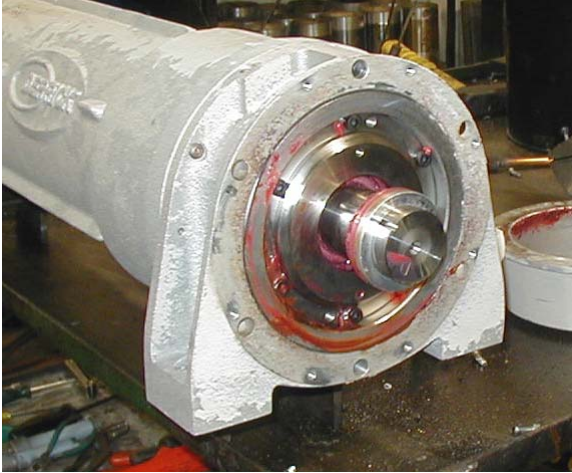

7 - CAREFULLY slide heated spacer off motor shaft.

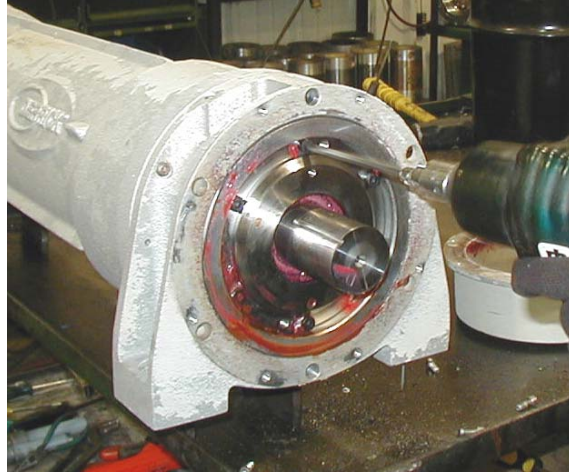

8 - Using a 6mm hex wrench, remove six socket head cap screws (M8-1.25x60) securing bearing mount to bearing housing.

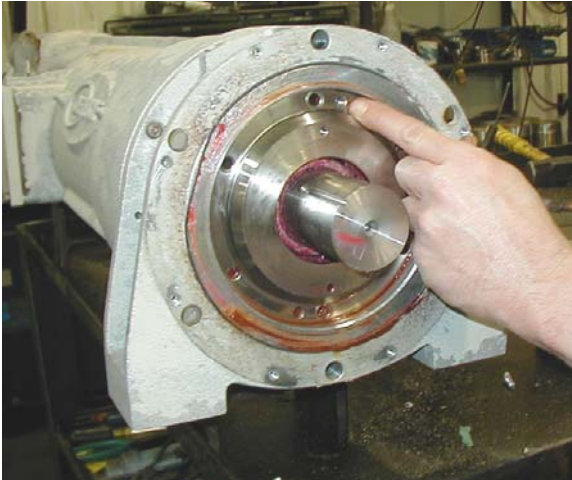

9 - Locate two threaded holes that accept the two M8-1.25x70 socket head jack screws. Jack screw holes are 180 degrees apart.

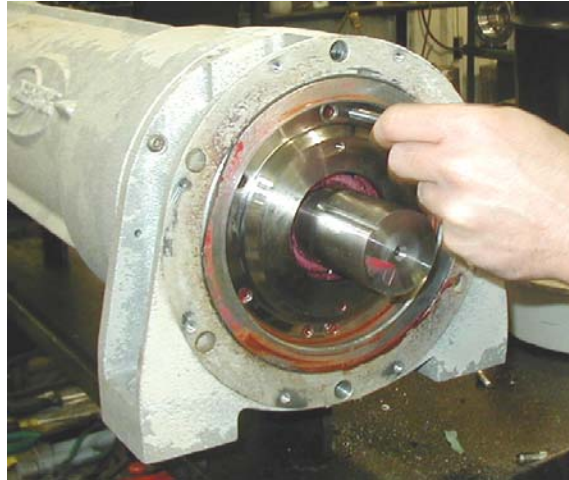

10 - Carefully thread jack screws into threaded holes in bearing mount, being sure to avoid cross-threading.

Bearing Removal (Cont'd)

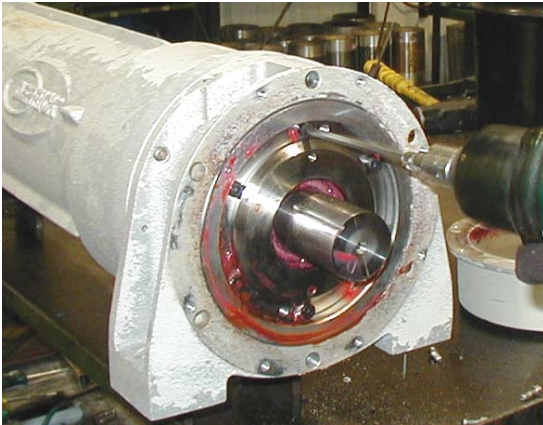

11 - Using a 6mm hex wrench, alternately and equally advance each jack screw a few turns at a time.

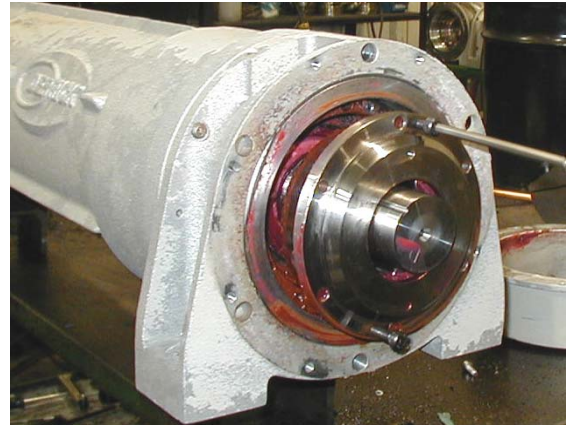

12 - As jack screws contact bearing housing, bearing mount is drawn from bearing housing as shown, while inner bearing race remains on shaft. Remove and discard bearing and bearing mount.



13 - Using a soft absorbent cloth, remove excess lubricant from interior of bearing housing and inner bearing race. Do not use compressed air for cleaning as this may drive contaminants into motor.

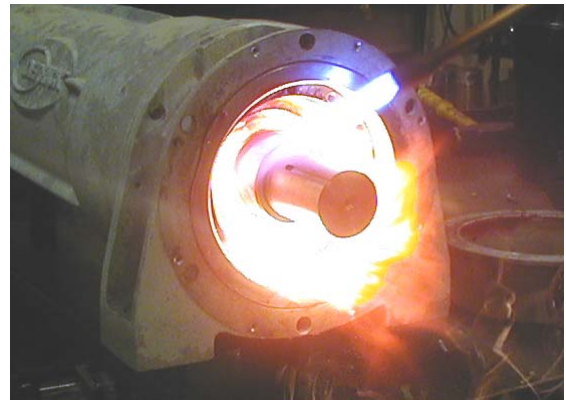

14 - Using a torch with a diffused flame, gently heat inner bearing race for no more than 10 seconds to approximately 200°-230°F (93°-110°C) to facilitate removal.

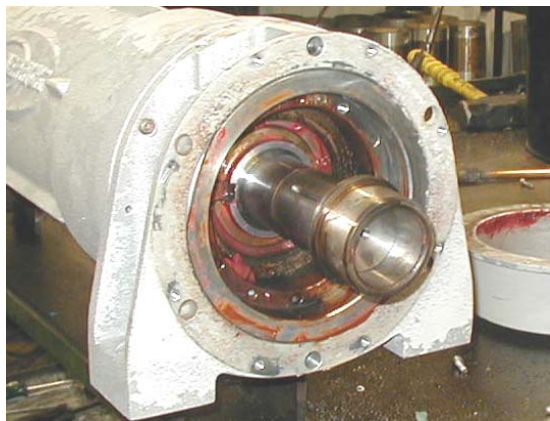

15 - **Carefully** remove and discard heated inner bearing race from motor shaft. Using a soft absorbent cloth, remove excess lubricant from interior of bearing housing. Do not use compressed air for cleaning as this may drive contaminants into motor.

EX, SGX VIBRATOR MOTORS

Bearing Installation

The following procedure describes installation of the bearing on one end of the motor. Repeat the procedure for the second bearing.

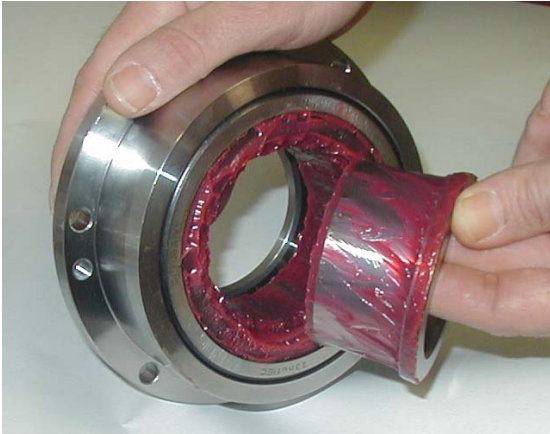

1 - Remove inner bearing race from assembled bearing and bearing mount supplied with bearing replacement kit. Be careful to avoid contaminating these components.

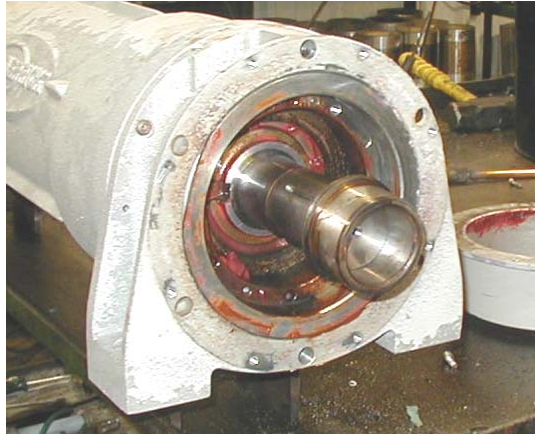

2 - Wipe excess lubricant from inner bearing race, and position on motor shaft with collar toward motor body. Using a bearing heater or a torch with a diffused flame, heat inner bearing race to approximately 200°-230° F (93° - 110° C).

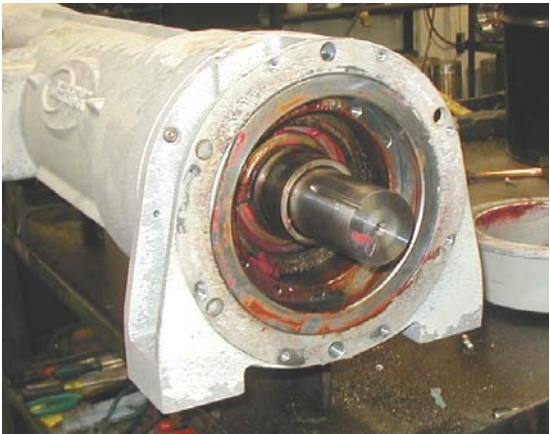

3 - After heating inner bearing race, slide bearing race onto motor shaft until shoulder of race contacts bearing seat in rear of cavity. Fully coat surface of inner race with grease (supplied with bearing replacement kit).



4 - Orient longer, reduced diameter of bearing mount toward motor body. Align clearance holes in bearing mount with threaded holes in bearing housing, and press bearing mount fully into bearing housing cavity.

Bearing Installation (Cont'd)

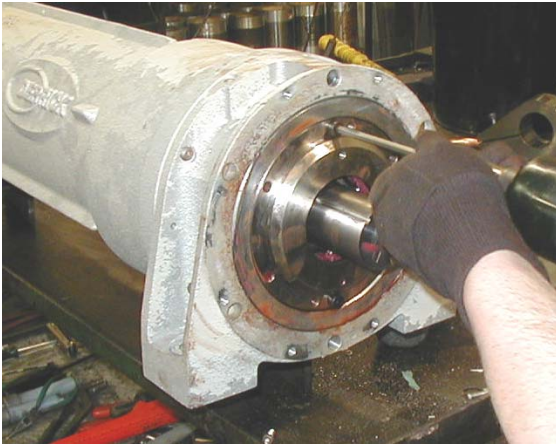

5 - Locate the two clearance holes in bearing mount 180degrees apart. Insert two M8-1.25x70 jack bolts supplied with bearing replacement kit through the clearance holes, and thread screws into holes in bearing housing. Alternately advance both jack bolts a few turns at a time until bearing mount is drawn well into bearing housing.

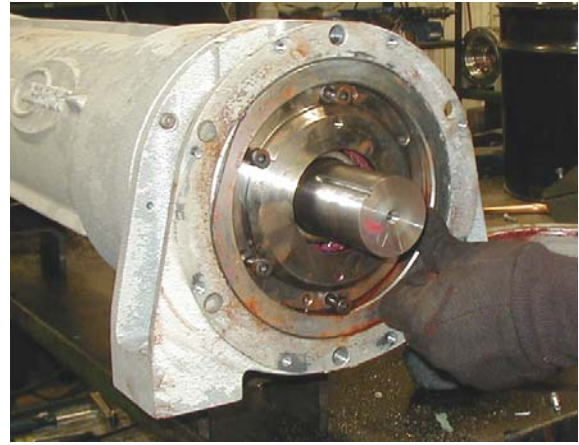

6 - After bearing mount has been sufficiently drawn into bearing housing, remove the two jack bolts and install original socket head cap screws (M8-1.25x60) into the six clearance holes. Hand tighten screws.

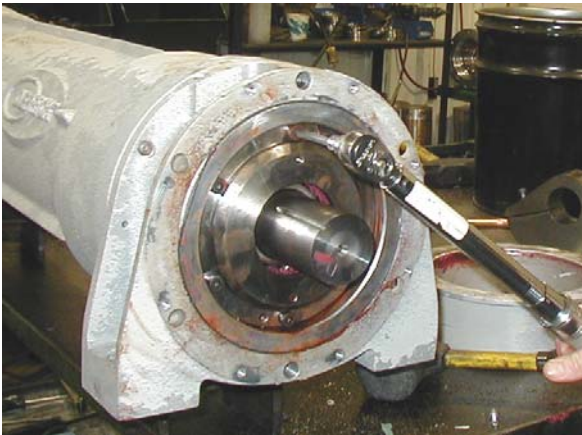

7 - Using a torque wrench and 6mm hex bit, alternately tighten all six cap screws to 250 in. lbs. Coat motor shaft with grease (included in bearing replacement kit).



8 - Using a bearing heater or torch with a diffused flame, gently warm spacer (no more than 10 seconds) to approximately 200°-230°F (93°-110 C). Slide heated spacer into contact with bearing.

EX, SGX VIBRATOR MOTORS

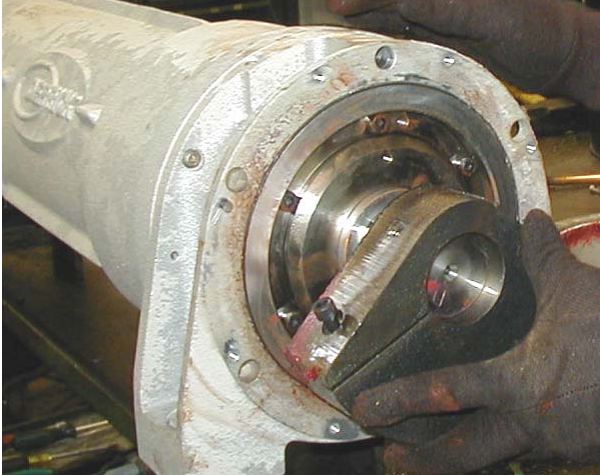

9 - Orient eccentric weight(s) with split facing junction box and pin on inside of weight aligned with keyway of motor shaft. If two weights are used, install heaviest weight closest to bearing mount.

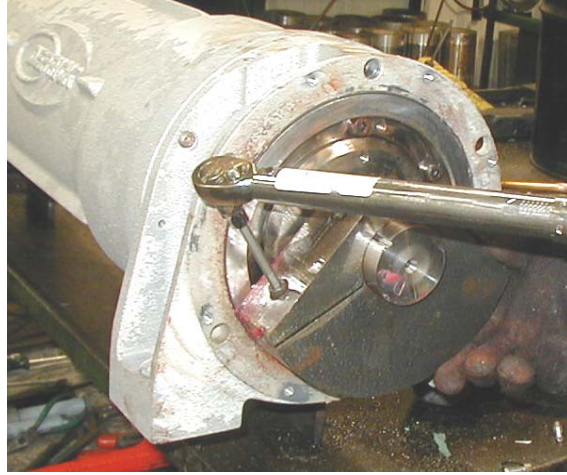

10 - Using a torque wrench and 6mm hex bit, tighten M8 cap screw to 250 in. lbs.

11 - Check rotation and axial play of motor shaft as follows:

- a. Manually rotate the eccentric weight both clockwise and counterclockwise, allowing weight to fully rotate. If binding is felt, disassemble motor as necessary to determine cause of binding, correct defect, and reassemble bearing in accordance with this procedure.
- b. Using both hands, grip eccentric weight(s) and push and pull along axial centerline of motor assembly. Shaft must have no more than 1/16"-1/8" (1.6-3.2 mm) of movement. If excessive axial movement is found, disassemble motor as necessary to determine cause of problem, correct defect, and re-assemble bearing in accordance with this procedure.



12 - Apply a small amount of grease to O-ring groove between bearing housing and bearing mount, and then **carefully** install O-ring in groove.

DO NOT STRETCH O-RING DURING INSTALLATION.

Position cover on motor case, and install six M6-1.0 x 16 screws hand tight. Using a torque wrench and a 5mm hex bit, tighten screws to 115 in. lbs.

TROUBLESHOOTING

The troubleshooting procedures presented in the following chart are designed to assist in fault isolation and correction of defects in Derrick EX and SGX vibrator motors.

Trouble	Possible Cause	Corrective Action
Motor fails to run	Incorrect voltage	Check that supply voltage agrees with motor data plate. If correct, check fuses / circuit breakers. Using a voltmeter, check for correct supply power to all three phases at starter(s). Using a voltmeter, verify that motor starter is functioning properly and terminals T-1, T-2, and T-3 are energized. Check for damage to power cable connected to motor junction box. Correct all defects.
	Incorrect power supply connections	Check electrical connections, and correct any defects.
Starter circuit overloads and trips	Incorrect supply voltage	Check that supply voltage agrees with motor data plate.
	Incorrect thermal overload	Check that thermal overload is capable of handling full load current. Replace overload, if inadequate (see motor data sheet for load data).
	Mounting hardware loose	Check that mounting hardware is properly tightened.
	Vibrating motion of motor and related components are restricted	Check that shipping brackets have been removed or disengaged as required. Check condition of float mounts. Verify that solids are not preventing motion of the screen frame. Correct all defects.
Excessive current draw	Incorrect supply voltage	Verify that supply voltage agrees with motor data plate.
	Incorrect thermal overload	Check that thermal overload is capable of handling full load current. Replace overload, if inadequate (see motor data sheet for load data).
	Mounting hardware loose	Check security of mounting hardware. Tighten as required.
	Vibrating motion of motor and related components restricted	Verify that shipping brackets have been removed / disengaged as required. Verify that float mounts are in good condition. Verify that solids are not preventing motion of the screen frame. Correct all defects.
Surface temperature too high*	Excessive buildup of process material on motor case	Wash off buildup from motor case.

EX, SGX VIBRATOR MOTORS

Trouble	Possible Cause	Corrective Action
Excessive noise	Loose hardware	Check security of all external and internal hardware. Tighten as required.
	Defective bearing	Replace both bearings in accordance with Bearing Replacement.
Motor turns too slowly	Incorrect supply voltage or line frequency	Check that supply voltage and line frequency agree with motor data plate. Frequency must be within $\pm 1\text{Hz}$.
Motors not synchronized (dual motors only)	No electric power to one motor	Check that supply voltage is connected to both motors.
	Incorrect electrical connections	Confirm that electrical connections are in accordance with the instructions in this section.

* Derrick vibrator motors run with higher surface temperatures than standard industrial motors. Refer to the maximum temperature rise indicated on the motor data plate attached to the motor case or the motor data sheet included in this manual.

DERRICK® CORP. - MOTOR DATA SHEET

DOC# PE-S-245-05

Wire Code

Power	Black, White & Red
Ground	Green
Thermal Switch	Orange & Blue

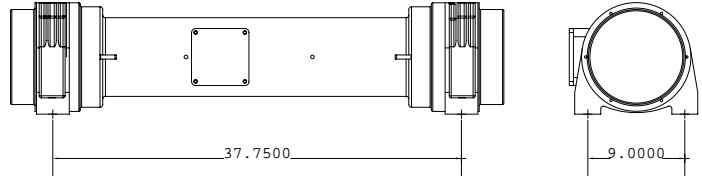

1500 RPM

MODEL: EX VIBRATOR - 50 HZ - (EXPLOSION PROOF TERMINAL BLOCK STYLE)

Vibrator Model	EX-215/220-50	EX-230/240-50	EX-380/400-50	EX-415-50	EX-440-50
Voltage [Volts]	215/220	230/240	380/400	415	440
Phase / Frequency [Hz]	3/50	3/50	3/50	3/50	3/50
Speed [RPM]	1500	1500	1500	1500	1500
Rated Horsepower [HP]	2.5	2.5	2.5	2.5	2.5
Current @ Idle / Full Load [Amps]	3.6 / 7.1	3.3 / 6.5	2.1 / 4.0	1.9 / 3.8	1.8 / 3.6
Locked Rotor Current [Amps] / Locked Rotor Code	28.4 / D	26.0 / D	15.6 / D	15.1 / D	14.2 / D
Fuse - Non Delay [Amps]	20	20	12	10	10
Overload protection [Amps]	8	7	5	4	4

Data below is common to all model **EX-50** vibrators.

Insulation class	F
Ambient temperature	55° C
Operating temperature code	T3C
Maximum temperature rise	46° C by Resistance
Duty	CONTINUOUS
Thermal switch rating	Pilot Duty 720VA, 110 – 600VAC
Thermal switch type	Normally Closed
Thermal switch temperature	Opens @ 145° C / Closes @ 140° C
Power factor - operations	99.13
Efficiency - running	98%
Service Factor	1.0
NEMA design	TENV
Ingress Protection	IP 56
Weight	415 lbs.-(189 kg)STEEL / 290 lbs.-(132 kg)ALUMINUM
Hazardous location (listed as)	CLASS 1 GROUPS C, D / CLASS 2 GROUPS E, F, G
Listing agency	UL
Hazardous location (listed as)	EEx d IIB T3
Listing agency	DEMKO

NOTE: Derrick® vibrators are fixed load devices with no means of altering the loading or power consumption. Power factor correction capacitors are not recommended for this motor.

DERRICK® CORP. - MOTOR DATA SHEET

DOC# PE-S-249-08

Wire Code

Power Black, White & Red
 Ground Green
 Thermal Switch Orange & Blue

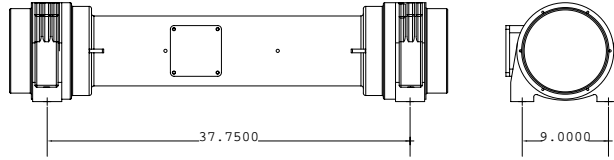

1800 RPM

MODEL: EX VIBRATOR - 60 HZ - (EXPLOSION PROOF TERMINAL BLOCK STYLE)

Vibrator Model	EX-215/220-60	EX-230/240-60	EX-380/400-60	EX-440-60	EX-460/480-60	EX-575/600-60
Voltage [Volts]	215/220	230/240	380/400	440	460/480	575/600
Phase / Frequency [Hz]	3/60	3/60	3/60	3/60	3/60	3/60
Speed [RPM]	1800	1800	1800	1800	1800	1800
Rated Horsepower [HP]	2.5	2.5	2.5	2.5	2.5	2.5
Current @ Idle / Full Load [Amps]	4.4 / 8.7	4.1 / 8.2	2.5 / 4.9	2.1 / 4.3	2.0 / 4.1	1.6 / 3.3
Locked Rotor Current [Amps] / Locked Rotor Code	34.9 / F	32.6 / F	19.6 / F	17.0 / F	16.3 / F	13 / F
Fuse - Non Delay [Amps]	25	25	15	12	12	10
Overload protection [Amps]	10	10	6	5	5	4

Data below is common to all model **EX-60** vibrators.

Insulation class	F
Ambient temperature	55° C
Operating temperature code	T3C
Maximum temperature rise	46° C by Resistance
Duty	CONTINUOUS
Thermal switch rating	Pilot Duty 720VA, 110 – 600VAC
Thermal switch type	Normally Closed
Thermal switch temperature	Opens @ 145° C / Closes @ 140° C
Power factor - operations	99.13
Efficiency - running	98%
Service Factor	1.0
NEMA design	TENV
Ingress Protection	IP 56
Weight	415 lbs.-(189 kg.) STEEL / 290 lbs.-(132 kg.) ALUMINUM
Hazardous location (listed as)	CLASS 1 GROUPS C,D / CLASS 2 GROUPS E,F,G
Listing agency	UL
Hazardous location (listed as)	EEx d IIB T3
Listing agency	DEMKO

NOTE: Derrick® vibrators are fixed load devices with no means of altering the loading or power consumption. Power factor correction capacitors are not recommended for this motor.

DERRICK® CORP. - MOTOR DATA SHEET

DOC# PE-S-250-03

Wire Code

Power Black, White & Red
 Ground Green
 Thermal Switch Orange & Blue

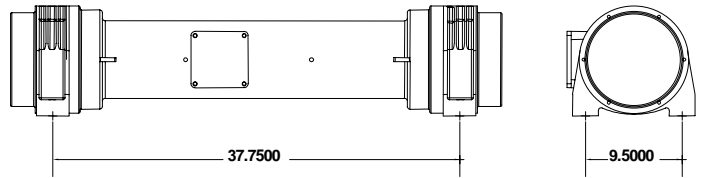

1500 RPM

MODEL: **SGX VIBRATOR - 50 HZ - (EXPLOSION PROOF TERMINAL BLOCK STYLE)**

Vibrator Model	SGX-215/220-50	SGX-230/240-50	SGX-380/400-50	SGX-415-50	SGX-440-50	SGX-690-50
Voltage [Volts]	215/220	230/240	380/400	415	440	690
Phase / Frequency [Hz]	3/50	3/50	3/50	3/50	3/50	3/50
Speed [RPM]	1500	1500	1500	1500	1500	1500
Rated Horsepower [HP]	2.5	2.5	2.5	2.5	2.5	2.5
Current @ Idle / Full Load [Amps]	3.6 / 7.1	3.3 / 6.5	2.1 / 4.0	1.9 / 3.8	1.8 / 3.6	1.1 / 2.3
Locked Rotor Current [Amps] / Locked Rotor Code	28.4 / D	26.0 / D	15.6 / D	15.1 / D	14.2 / D	9.1 / D
Fuse - Non Delay [Amps]	20	20	12	10	10	7.5
Overload protection [Amps]	8	7	5	4	4	3.5

Data below is common to all model **SGX-50** vibrators.

Insulation class	F
Ambient temperature	55° C
Operating temperature code	T3C
Maximum temperature rise	46° C by resistance
Duty	CONTINUOUS
Thermal switch rating	Pilot Duty 720VA, 110 – 600VAC
Thermal switch type	Normally Closed
Thermal switch temperature	Opens @ 145° C / Closes @ 140° C
Power factor - operations	99.13
Efficiency - running	98%
Service Factor	1.0
NEMA design	TENV
Ingress Protection	IP 56
Weight	415 lbs.-(189 kg) STEEL / 290 lbs.-(132 kg) ALUMINUM
Hazardous location (listed as)	CLASS 1 GROUPS C, D / CLASS 2 GROUPS E, F, G
Listing agency	UL
Hazardous location (listed as)	EExd IIB T3
Listing agency	DEMKO

NOTE: Derrick® vibrators are fixed load devices with no means of altering the loading or power consumption. Power factor correction capacitors are not recommended for this motor.

DERRICK® CORP. - MOTOR DATA SHEET

DOC# PE-S-251-03

Wire Code

Power Black, White & Red
 Ground Green
 Thermal Switch Orange & Blue

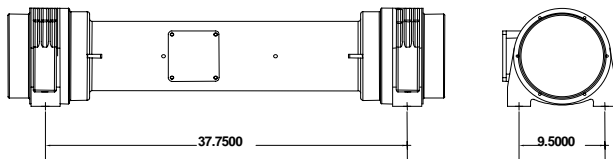

1800 RPM

MODEL: SGX VIBRATOR - 60 HZ - (EXPLOSION PROOF TERMINAL BLOCK STYLE)

Vibrator Model	SGX-215/220-60	SGX-230/240-60	SGX-380/400-60	SGX-440-60	SGX-460/480-60	SGX-575/600-60
Voltage [Volts]	215/220	230/240	380/400	440	460/480	575/600
Phase / Frequency [Hz]	3/60	3/60	3/60	3/60	3/60	3/60
Speed [RPM]	1800	1800	1800	1800	1800	1800
Rated Horsepower [HP]	2.5	2.5	2.5	2.5	2.5	2.5
Current @ Idle / Full Load [Amps]	4.4 / 8.7	4.1 / 8.2	2.5 / 4.9	2.1 / 4.3	2.0 / 4.1	1.6 / 3.3
Locked Rotor Current [Amps] / Locked Rotor Code	34.9 / F	32.6 / F	19.6 / F	17.0 / F	16.3 / F	13 / F
Fuse - Non Delay [Amps]	25	25	15	12	12	10
Overload protection [Amps]	10	10	6	5	5	4

Data below is common to all model **SGX-60** vibrators.

Insulation class	F
Ambient temperature	55° C
Operating temperature code	T3C
Maximum temperature rise	46° C by Resistance
Duty	CONTINUOUS
Thermal switch rating	Pilot Duty 720VA, 110 – 600VAC
Thermal switch type	Normally Closed
Thermal switch temperature	Opens @ 145° C / Closes @ 140° C
Power factor - operations	99.13
Efficiency - running	98%
Service Factor	1.0
NEMA design	TENV
Ingress Protection	IP 56
Weight	415 lbs.-(189 kg.) STEEL / 290 lbs.-(132 kg.) ALUMINUM
Hazardous location (listed as)	CLASS 1 GROUPS C,D / CLASS 2 GROUPS E,F,G
Listing agency	UL
Hazardous location (listed as)	EExd IIB T3
Listing agency	DEMKO

NOTE: Derrick® vibrators are fixed load devices with no means of altering the loading or power consumption. Power factor correction capacitors are not recommended for this motor.